

TOP

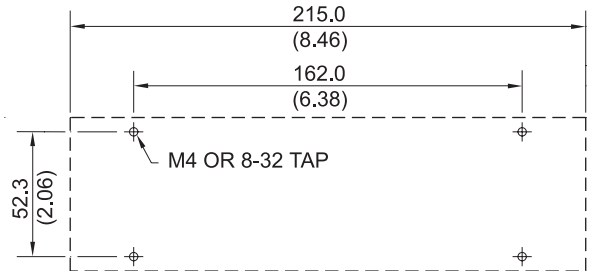

MOUNTING DETAIL

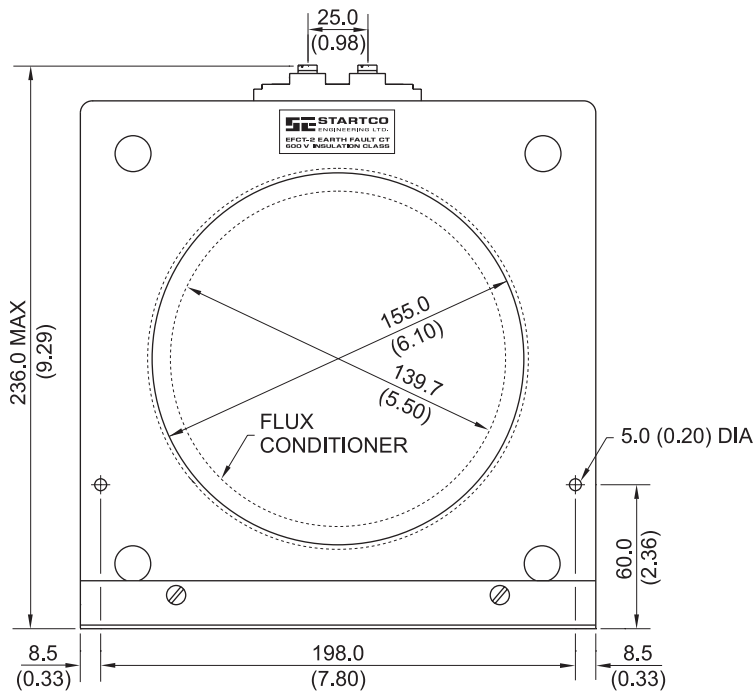

FRONT

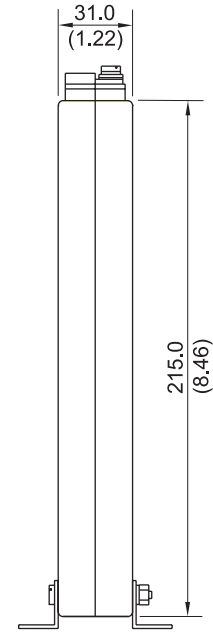

SIDE

NOTES:

1. DIMENSIONS IN MILLIMETRES (INCHES).
2. MOUNTING SCREWS: M4 OR 8-32.

EFCT-2 OUTLINE AND MOUNTING DETAILS